

FRD

FURUKAWA

PRODUCT GUIDE



FRD FURUKAWA ROCK DRILL

Furukawa is always there.

New lineup of demolition tool, blast hole drill,



Technology For Our Future

tunneling jumbo drill.

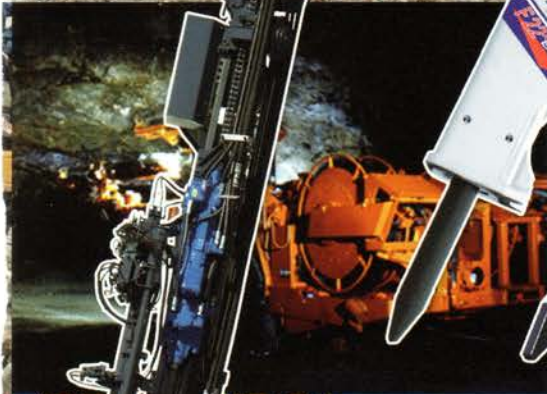

In 1914 FURUKAWA has produced Japan's first original pneumatic rock drill. Since then we have striven in developing products and improving machine efficiency. The rock drills we produce have contributed to developing society in fields like mining, quarry, tunnel, dam construction, road construction, etc.

In 1976 we developed our first hydraulic breaker, and in the following year, our first original hydraulic crawler drill went on the market.

FURUKAWA is the only company in the world to develop both hydraulic breakers and crawler drills with its own proprietary technology.

We shall continue to pursue in the quest to realize harmony with nature while contributing to the development and happiness of mankind.

Product Guide

Hydraulic Breaker

Hydraulic Crusher

Hydraulic Crawler Drill

Down The Hole Drill & Rotary Drill

Tunnel Jumbo

Mining Jumbo

Concrete Sprayer

Pneumatic Crawler Drill

Pneumatic Tool

Drilling Accessory



Hydraulic Breaker

Suited to your needs. Performance & Quality.

FRD has a wide variety of models in our product line, for mini-excavators through giant-excavators.



Hydraulic Breaker



BHL Version



Specifications

Model		Fx15	Fx25	Fx35	Fx45	Fx55
Body weight	kg	36	56	80	110	150
Operating weight						
*T-BOX / NT-Box incl. Top bracket	kg	-	112	157	208	281
Side Plate incl. Top bracket	kg	60	83	129	165	220
Height						
*T-BOX / NT-Box excl. Top bracket	mm	-	1,097	1,209	1,342	1,440
Side Plate excl. Top bracket	mm	924	1,030	1,172	1,285	1,388
Width						
T-BOX / NT-Box excl. Top bracket	mm					
Side Plate excl. Top bracket	mm	180	180	214	214	235
Impact rate	min ⁻¹	600-1,500	600-1,500	600-1,300	600-1,100	500-1,100
Oil flow rate	L/min	10-22	18-32	24-42	30-56	40-72
Operating oil pressure	MPa	10-14	10-14	12-16	12-16	12-16
Rod diameter	mm	36	45	52	60	68
Hose diameter	mm	9	12	12	12	12
Excavator weight	ton	1.0-1.5	1.5-2.5	2.5-3.5	3.5-4.5	4.5-5.5
Piston idle blow enabling function		STD	STD	STD	STD	STD
High pressure protector function		—	—	—	—	—
Manual stroke adjustment function		—	—	—	—	—
Dust intake prevention function		—	—	—	—	—
Two-way back head		—	—	—	—	—

Remarks *Mark is shown as T-BOX for F6 to F12 & F70, F100, NT-Box for Fx25 to Fx55 & F19 to F45.

NT-BOX Frame Type



New-T-BOX frame design achieves total performance and lower sound level, features sound and vibration deadening for quieter operation. Less bolts and nuts design also makes scheduled maintenance quick and returns breaker back for field.

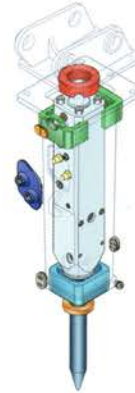
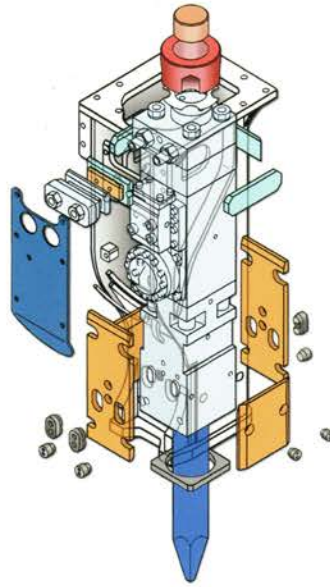

Side plate Type



F19



F22



F27



F35



F45



F70

F6	F9	F12	F19	F22	F27	F35	F45	F70	F100
195	300	500	640	865	960	1,210	1,590	2,250	3100
350	535	860	1,290	1,640	1,860	2,365	3,000	4,310	6800
365	550	910	1,390	1,775	2,200	2,525	3,325	-	-
1,617	1,835	2,214	2,598	2,666	2,895	3,088	3,280	3,810	4410
1,630	1,855	2,229	2,498	2,683	2,925	3,090	3,270	-	-
260	321	391	500	500	600	600	600	760	840
260	321	391	500	500	600	600	600	-	-
650-1,050	550-900	450-625	400-525	360-460	340-440	320-400	300-350	250-320	200-350
50-90	65-110	100-130	120-155	145-180	155-190	175-220	200-250	250-340	280-390
10-14	12-15	16-18	16-18	16-18	16-18	16-18	16-18	16-18	16-18
75	90	105	120	135	140	150	165	180	210
19	19	19	25	25	25	25	32	32	32
5.5-6.5	6.5-9.0	9.0-14	14-19	19-22	22-26	26-32	32-44	44-70	65-100
STD	STD	STD	STD	STD	STD	STD	STD	STD	STD
-	-	STD	STD	STD	STD	STD	STD	OP	-
STD	STD	STD	STD	STD	STD	STD	STD	STD	STD
-	-	STD	STD	STD	STD	STD	STD	STD	-
-	-	-	-	STD	STD	STD	STD	STD	-

Hydraulic Crushers

V Series Hydraulic Crushers, light yet tough frame design.

FRD V series crushers take task of quiet demolition through re-cycling demolished building debris.

Hydraulic Crushers



Specifications

Model		Vs9	Vs15	Vs22	Vs22FTR	Vs30	Vs45
Operating weight (Flat-top model)	kg	660	1,120 (1,150) *1	1,760 (1,780) *1	— (2,290) *1	2,760 (2,725) *1	4,265
Total length	mm	1,462	1,680	2,008	2,170	2,218	2,375
Max. Jaw opening	mm	600	740	880	790	1,030	1,165
Crushing force at center teeth	kN	540	790	910	910	1,355	1,580
Cutter length	mm	140	160	180	180	240	240
Working oil pressure	MPa	22 - 25	28 - 32	28 - 32	28 - 32	28 - 32	32
Oil flow	L/min	50 - 80	80 - 220	150 - 400	150 - 400	150 - 400	250 - 700
Excavator weight	ton	5 - 12	10 - 20	17 - 26	17 - 26	26 - 40	32 - 44
High-speed valve		STD	STD	STD	STD	STD	STD
Hydraulic rotation		—	—	—	OP	—	—

*1 : Single tooth

STD : standard, OP : optional

Secondary Crusher Vs Series



The Vs series is engineered to crush concrete into small pieces. A wedge-shaped center tooth crushes concrete for re-cycling. A pair of cutters is provided to cut rebar

Secondary Crusher Vs22FTR



Incorporates hydraulic rotation system with the secondary crusher of Vs22.

Flat-top Vs for flat-adapter



Designed to couple with a quick disconnect system.

Primary Crusher Vx / Vp Series (Dual Cylinder)



The Vx & Vp features dual cylinders and has a larger jaw opening. Features include an extreme-tensile strength alloy steel structure.

Multi-purpose Crusher Vm-series



Even in hard-to-access locations, this crusher can target an object from various angles. It can cut steel frames when demolishing buildings as well as crush concrete block.

Combi Cutter / Crusher Vc Series



The Vc series can demolish both concrete and steel structures. It is capable of shearing heavy I-beams with its sharp blades, as well as crushing chunks of concrete with the center tooth.

Vx225	Vp9	Vp15	Vp22	Vm9	Vm15	Vm22	Vc9	Vc15	Vc22
2,250 —	800 (860)	1,570 (1,545)	2,630 (2,700)	730 (790)	1,290 (1,320)	1,980 (2,040)	720 —	1,200 (1,260)	2,230 (2,293)
2,464	1,540	2,065	2,440	1,790	2,065	2,470	1,620	1,995	2,610
1,100	480	820	1,100	520	700	920	494	660	880
1,665	635	850	1,260	420	640	800	616* ²	1,050* ²	1,475* ²
200	80	155	210	140	160	180	300	340	530
32	22 - 25	28 - 32	28 - 32	22 - 25	28 - 32	28 - 32	25	32	32
150 - 400	50 - 80	80 - 150	150 - 250	50 - 80	80 - 150	150 - 250	50 - 80	80 - 220	150 - 400
19 - 25	8 - 15	15 - 20	20 - 30	7 - 12	13 - 20	19 - 25	7 - 12	13 - 20	20 - 30
STD	STD	STD	STD	STD	STD	STD	STD	STD	STD
OP	—	OP	OP	OP	OP	OP	—	OP	OP

*2 : Crushing force at center cutter

Hydraulic Crawler Drill

FRD has achieved ultimate combination of performance and economy.

With the field proven HD700 series drifter and IDS, it's easier than ever before to drill FAST & STRAIGHT.



HD700 series Dual Damper System (DDS)

FURUKAWA HD700 series: drifter delivers superior performance. With the HD700 series, it's easier than ever before to drill faster and straight.

Advanced drifter system

FRD has developed Dual Damper System first in the industry. For maximum energy transfer, Active DDS minimizes return of shock waves by keeping the bit firmly against the rock at all times during drilling. Active DDS minimizes percussion energy loss and, by optimizing the overall feed force required, produces straighter holes. An additional benefit is greatly improved life of drilling accessories.

Hydraulic Crawler Drill

HCR1500-ED II



HCR1500-ED II Shown

Model	HCR1500-D20 II	HCR1500-ED II
Operating weight	18,420kg	17,170kg
Drifter model	HD715	
Free air delivery	13.5m ³ /min	
Boom type	Fix	Extension
Bit diameter	89~127mm	
Rod diameter	51R (45R)	
Rod length	6,100mm(20ft)	3,660mm(12ft)

HCR1200-ED II

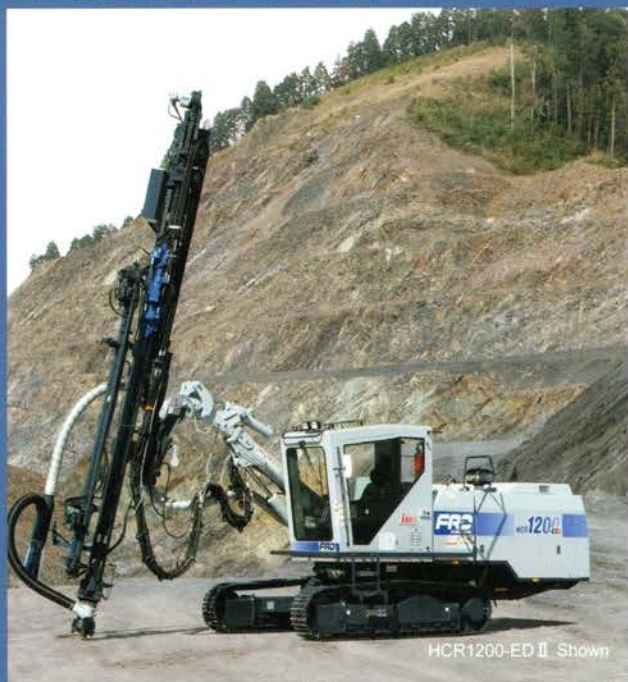

HCR1200-ED II Shown

Model	HCR1200-ED II
Operating weight	14,830kg
Drifter model	HD712
Free air delivery	7.8m ³ /min
Boom type	Extension
Bit diameter	76~102mm
Rod diameter	45R (38R,51R)
Rod length	3,660mm(12ft)

HCR1200-DSⅢ



HCR1200-DSⅢ Shown

Model	HCR1200-DSⅢ
Operating weight	11,900kg
Drifter model	HD712
Free air delivery	7.1m ³ /min
Boom type	Fix
Bit diameter	76~102mm
Rod diameter	45R
Rod length	3,660mm(12ft)

HCR900-ES II



HCR900-ES II Shown

Model	HCR900-ES II
Operating weight	10,250kg
Drifter model	HD709
Free air delivery	6.1m ³ /min
Boom type	Extension
Bit diameter	65~90mm
Rod diameter	38R (32H,38H,45R)
Rod length	3,660mm(12ft) or 3,050mm(10ft)

HCR910-DS



HCR910-DS Shown

Model	HCR910-DS
Operating weight	10,450kg
Drifter model	HD709
Free air delivery	5.4m ³ /min
Boom type	Fix
Bit diameter	65~90mm
Rod diameter	38R (32H,38H,45R)
Rod length	3,050mm(10ft)

Down The Hole Drill & Rotary Drill

FRD's answer for volume production.

FRD never stops step for development of new product. Down the hole drills and rotary drills are the recent answer for the demand of volume production machines. Power range of 328kW through 567kW machines were newly launched.



Down The Hole Drill & Rotary Drill



DCR45

DTH / Rotary Drill : Crawler type DCR45



Model	DCR45
Operating weight	48,000kg
Engine output	567 kW / 1,900min ⁻¹
Max. torque of drill motor	1 speed, 12,5 kN·m
Compressor	
Max. air pressure	2.5 MPa
Free air delivery	35.7 m ³ /min
Bit diameter	203~251mm
Rod diameter	178mm
Rod length	10,100mm

Down The Hole Drill DCR20



Model	DCR20
Operating weight	21,000kg
Engine output	328 kW / 2,100 min ⁻¹
Max. torque of drill motor	3.25 kN·m
Compressor	
Max. air pressure	2.5MPa
Free air delivery	24.3 m ³ /min
Bit diameter	89~165mm
Rod diameter	76mm, 89mm, 102mm
Rod length	4,000mm, 5,000mm, (6,000mm)

PCR-DTH



Model	PCR-DTH
Operating weight	5,100kg
Air consumption	22m ³ /min
Bit diameter	89~203mm
Rod diameter	76mm
Rod length	1,500mm or 3,070mm

Tunneling Jumbo Drill

FRD has drilled every difficult tunnels.

FRD tunneling jumbos have encountered every kind of drilling difficulties and drilled through them.



Tunneling Jumbo Drill



Tunnel Work Station (TWS)
Self-propelling 2-boom
with concrete sprayer



JTH3200R
3-boom, 2-cage Wheel Jumbo
With HD210 Hydraulic drifter



T3RW-210
Wing Boom Yoke Type
With HD210 Hydraulic drifter

Model	JTH3200R	T3RW-210
Drilling coverage (width x height)	13.22m x 8.84m	15.2m x 12.1m
Operating weight	43 ton	48 ton
Drifter	HD210 x 3	HD210 x 3
Boom	JE331-MARK4x3	JE331-MARK4x3
Charging cage	ZN720 x 2	ZN720 x 1
Engine output	128kW / 2000min ⁻¹	122.7kW
Electric motor for power pack	55kW x 3	55kW x 3
Steering	Rear axle power steering	Rear axle power steering

Mining Jumbo

FRD also manufactures custom build mining machines to meet demand of world under ground mining.



1-boom wheel jumbo



2-boom wheel jumbo



Scaling jumbo



Crawler breaker for mining



Fan cut drill

Concrete Sprayer : CJM Series

CJM2200 is the self propelled concrete sprayer for large diameter tunnel. Machine sprays quick hardening concrete over the tunnel surface that is steel supported or not supported.

CJM1800 is a low profile sprayer designed for under ground mine.



CJM1800M



CJM2200E with straight boom

Model	CJM1800M	CJM2200E
Operating weight	16 ton	24 ton
Concrete spray rate	18.0 m ³ /h	22.0 m ³ /h
Length x Width x Height	11.35m x 2m x 2.45m	15.6m x 3m x 4m
Boom slide length	—	2m
Nozzle slide length	2m	2m
Spraying coverage (Height x Width)	5.2m x 7.8m	10m X 13.3m

Pneumatic Crawler Drill PCR200

Features onboard low noise, high performance pneumatic drifter. Durable and easy maintenance with PCR200



Model	PCR200
Operating weight	5,000kg
Drifter model	PD200
Air consumption	16m ³ /min
Bit diameter	φ 65~100mm
Rod diameter	38R
Rod length	3,050mm or 3,660mm

Pneumatic tools

Furukawa has developed and manufactured pneumatic drills since 1917.



CA7 Pick Hammer
For digging soft rocks and crushing and ditching concrete.

CA7 : 7.0kg



6D Palm drill
For breaking hard concrete structures, ditching, simple work on roads.

6D : 5.9kg



AA1 Air auger
For drilling soft rocks and clay rocks easier than percussion rotary drill.
AA1 : 8.8kg



322D Leg drill
For drilling horizontal with pressure water in tunnel and mine.



Paving breaker
For breaking hard concrete structures, ditching, simple work on roads.



B30 : 15.5kg
B40 : 18.5kg
B44 : 36.5kg
B60 : 30.5kg
B90 : 42.0kg



Hand drill
For downward drilling in quarries, road construction.



322D : 26.9kg
LB56 (Leg) : 13.5kg
PD90L : 28.6kg
LC77 (Leg) : 19kg

112D : 13.6kg
217D : 20.8kg
22D : 26.9kg



Each model is available as optional shock-absorbent type.

Drilling accessories

FRD designs and manufactures bits and shank rods for powerful rock drills based on our extensive knowledge of everything to do with drilling.



Item		Overall length	Shank size	Model
Pick steel		400mm 450mm 600mm	R26 x 80mm	CA7
Steel		400mm 450mm 600mm	H22 x 83mm	B30
Spade			H25 x 108mm	B40
			H28 x 152mm	B60
			H32 x 152mm	B90
Taper rod		250 ~ 1100mm (15T) 300 ~ 1000mm (19T)	R19-H14.6 x 88mm	6D
			600, 900, 1200, 1500, 1800, 2100, 2400, 2700mm	H22 x 83mm
	H22 x 108mm			217D
	H22 x 108mm H25 x 108mm			22D
	H22 x 108mm			322D
				H22 x 108mm

Item		Gauge	Rod size
Carr bit		26, 28, 30, 32, 34, 36mm	19mm
		28, 30, 32, 34, 36, 38, 40, 42, 44, 50, 55, 60, 65mm	22mm
Insert bit for 6D		20, 22mm	15T
		24, 26mm	19T

Item		Diameter (in.)	Thread
Button bit		45mm (1 3/4) 51mm (2)	R32
The Button bit is suitable for drilling hard rock with carbide tips.		64mm (2 1/2) 70mm (2 3/4) 76mm (3)	1600 T38
Cross bit		70mm (2 3/4) 76mm (3) 80mm, 89mm (3 1/2) 102mm (4)	T45
The cross bit makes it easy to regrind for stable drilling.		89mm(3 1/2) 102mm(4) 125mm(5)	T51

Shank rod	Drifter	Thread
	HD90	R32 (R38)
	HD210	R38 (R32)
	HD709, HD609, HD300	T38 (T45)
	HD712, HD612	T45 (T51)
	HD715, HD615	T51

Extension rod	Thread	Length	Shape	Both ends	
Male / Male rod	R32-R38	3700mm 4310mm 4500mm	32H	Male/Male	
		R32(R35)-R38 R32(R35)-T38	3700mm 4310mm 4500mm	35H	Male/Male
Male / Female rod	T38	3050mm (10ft) 3600mm (12ft)	38R 32H	Male/Male, Male/Female	
		T45	3050mm (10ft) 3600mm (12ft)	45R	Male/Male, Male/Female
			T51	3600mm (12ft) 6100mm (20ft)	51R

Drilling accessories



FRD Furukawa reserves right to change specifications without prior notice.

FRD FURUKAWA ROCK DRILL CO.,LTD.

5-3, 1-chome, Nihonbashi, Chuo-ku, Tokyo 103-0027, Japan
Tel +81-3-3231-6982 Fax +81-3-3231-6994



Yoshii works and Takasaki works have
been ISO9001, ISO14001 certified.

Product guide-E1204-F7
Printed in Japan